



Perimeter Protection Systems

Bollards, road blockers, tyre killers

Global innovation: High Security bollard with electromechanical operator

4Ddoors
GARAGE DOORS REDEFINED

HÖRMANN





- 4 Hörmann brand quality
- 6 Good reasons to try Hörmann
- 8 Quality and safety testing

- 10 **Security Line**
- 12 Automatic bollards
- 15 Semi-automatic bollards
- 16 Removable bollards
- 17 Fixed bollards

- 20 **High Security Line**
- 22 Safety certifications
- 23 Automatic bollards
- 24 Removable bollards
- 25 Fixed bollards
- 26 Road blockers
- 29 Tyre killers

- 30 Standard equipment for bollards
- 31 Optional equipment for bollards
- 32 Optional equipment for road blockers and tyre killers

- 33 Key switch posts
- 34 Accessories

- 38 Hörmann product range

Copyright: No part or excerpt may be reproduced without our prior permission.
Subject to changes. The products shown are example applications – no guarantee.

The products may only be permitted for use in specially secured areas and installation may need to be approved by the authorities and coordinated in advance. Please note local building regulations.

Hörmann brand quality

Future-oriented and reliable

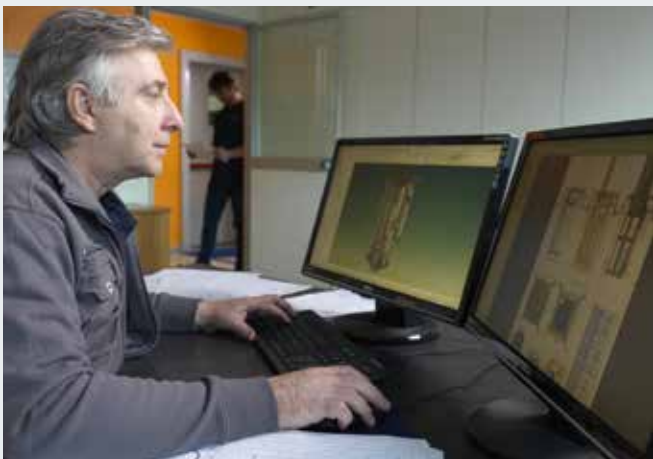

In-house product development

At Hörmann, innovation is produced in-house – highly qualified employees of the development departments are in charge of product optimisation and new developments. This results in market-ready, high-quality products that are very popular around the globe.



Modern manufacturing

All major system components are developed and manufactured by Hörmann, guaranteeing high compatibility, full functionality and optimal safety.



As Europe's leading manufacturer of construction components, we are committed to high product and service quality. This is how we set standards on an international scale.

Highly-specialised factories develop and produce industrial doors, operators, loading technology and perimeter protection systems that are marked by excellent quality, functional safety and a long service life.

Our wide range of bollards with different functions, road blockers and tyre killers, through to complete control concepts make us a strong, future-oriented partner for perimeter protection systems.



It goes without saying that spare parts for all our components are original Hörmann parts that come with a 10-year guaranteed availability.



Competent advice

Experienced specialists within our customer-oriented sales organisation accompany you from the planning stage, through technical clarification up to the final building inspection. Complete working documentation, such as technical manuals, is not only available in printed form, but also always accessible and up-to-date at www.hoermann.com



Efficient service

We recommend a semi-annual maintenance cycle for our perimeter protection systems. Our extensive service network means that we are always nearby and at your service around the clock.

Good reasons to try Hörmann

The market leader has all the innovations

*Global innovation:
High Security bollard with
electromechanical operator*



Automatic bollard
A220-600 H

Semi-automatic bollard
S 220-600 G

Fixed bollard
F 220-600 CF

1 Environmentally-friendly and flexibly fitted

For bollards with an **integrated hydraulic operator**, all the functional components are installed in the bollard unit. The integrated hydraulic system requires only a small amount of oil, reducing the environmental risk significantly. Optionally, you can choose biodegradable oil without a surcharge to rule out environmental risks completely. **Security and High Security bollards with integrated electromechanical operator** are particularly environmentally-friendly and low maintenance. Because they do not require hydraulic oil, they also meet strict environmental regulations.

Another advantage of both versions: The control can be fitted up to 80 m away from hydraulic bollards or 50 m away from electromechanical bollards using a power / connection cable.

2 Matching bollard versions

The cylinders of all bollards in the individual systems have a matching appearance, allowing for a **customised combination of Security and High Security Line bollards**. In addition, fixed, semi-automatic and automatic bollards can be combined perfectly thanks to the bottom plate with a matching appearance. **The result is a harmonious overall look.**



3

Security fast in case of emergency

An open driveway does not have to pose a security threat. Thanks to the EFO emergency function (Emergency Fast Operation), the lowered bollards and road blockers as well as tyre killers are **extended very quickly, in just about 1.5 seconds**, offering security fast in emergency situations.



4

Individual control concepts

Complete control concepts, e.g. comprising multiple bollards, can be operated using a single control. The concept also allows master and slave relationships to be configured between the bollards. The control is connected via service-friendly quick-connect terminals. **These simplify fitting and make subsequent maintenance easier.** The control can also be extended with control elements (such as code switches) and / or other activating kits, e.g. for induction loops.



The perimeter protection systems can also be conveniently operated using the BiSecur radio system. The extremely secure BiSecur encryption protocol, developed by Hörmann, makes sure that no one can copy your radio signal.

Quality and safety testing

For maximum safety and function



New and further developments in the Security Line and High Security Line are tested in both internal and external tests, examining the resistance to collisions with different loads, as well as their function depending on temperature and weather.

Climatic testing

Functional safety is ensured in various climatic conditions through special climatic tests. Different temperatures (from -30°C to $+50^{\circ}\text{C}$), weather conditions and humidities are simulated in climatic test chambers. These tests have high demands and guarantee the reliable function and long service life of our perimeter protection systems.

Pendulum impact testing

The impact resistance of bollards is examined in special pendulum impact tests. A steel ball on a pendulum simulates the loads resulting during an impact with different speeds and vehicle types. The impact height is also tested individually. This allows us to ensure and even improve upon the high safety of our bollards.

Uncompromising functional safety

All perimeter protection systems are tested to ensure full functionality before delivery. All fine mechanical and hydraulic adjustments and the electric and electronic settings of each individual system component are tested. For systems with multiple components, the compatibility of all interfaces and functions is ensured. With this process, we can guarantee the fastest fitting possible as well as reliable operation of our perimeter protection systems.

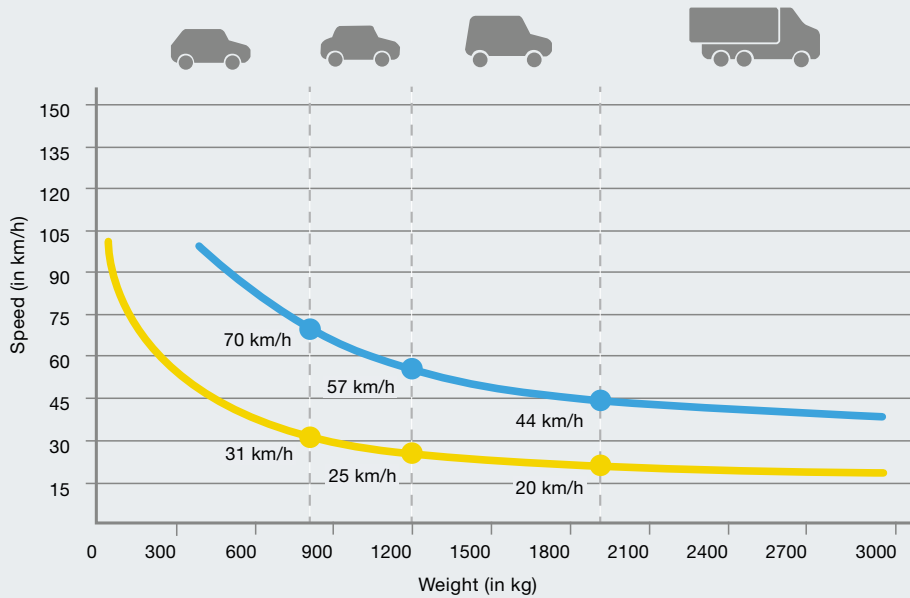

Vehicle types

- Small vehicles with a total weight of up to 800 kg
- Passenger cars with a weight of up to 1200 kg
- Vans with a weight of up to 1900 kg
- Lorries with a weight over 1900 kg

Impact energy with destruction*

■ 150000 J

Impact energy without destruction*

■ 30000 J

* using the example of bollard F 220-600 / 800 CF

The security provided by a bollard is measured based on different impact energies. The energy caused by a colliding vehicle depends on the vehicle type, weight and speed. The impact energy is crucial when it comes to damage and the function of the bollards.

Impact energy with destruction

The values in the diagram above indicate at which speed and which vehicle weight a certain impact energy is generated in which the passage is prevented with destruction of the bollard. For example, a vehicle with a speed of 57 km/h and a weight of 1200 kg hitting the bollard results in an impact energy of 150000 Joule. The passage of the vehicle is avoided, but the crash causes permanent damage to the mechanics and construction of the bollard and the bollard must be replaced.

Impact energy without destruction

The values in the diagram above indicate at which speed and which vehicle weight a certain impact energy is generated in which the passage is prevented without destruction of the bollard. For example, a vehicle with a speed of 25 km/h and a weight of 1200 kg hitting the bollard results in an impact energy of 30000 Joule. The passage of the vehicle is avoided and the function and safety of the bollard are still guaranteed.

Security Line

Security for private and public applications



Automatic bollards

Automatic bollards are available in three versions: one version with an integrated **electromechanical operator** for average use frequencies and a variant with an **integrated hydraulic operator** for very frequent use. The third variant, **automatic bollard RI-H** with reinforced cylinder material, offers particularly high protection.



Semi-automatic bollards

Semi-automatic bollards with **integrated gas springs** are suitable for less frequent use. Installation does not require a power connection.



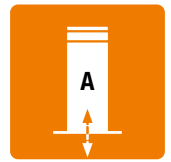

SECURITY



Removable bollards

Removable bollards, which can be detached without any tools, are recommended for very infrequent use of approximately 2 cycles per day.



Fixed bollards

The **fixed bollards with bottom plate** have a matching appearance with automatic and semi-automatic bollards. If damaged, the cylinders can be removed. The **fixed bollards with ground anchor** make for an introductory model featuring an excellent price-performance ratio. **Fixed bollards RI-FF with reinforced cylinder material and reinforced ground fitting** are ideal for particularly high protection.

Automatic bollards E

With integrated electromechanical operator

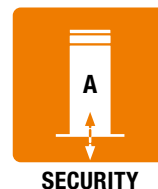

A 275-600 E / A 275-800 E

- For average use frequencies (approx. 100 cycles / day)
- **Introductory model featuring an excellent price-performance ratio**
- Automatic lifting and lowering by integrated electromechanical operator
- Control unit for controlling max. 3 bollards
- Distance between bollard and control unit of up to 30 m



● Standard equipment

For information about the equipment options, see pages 30 – 31.

	A 275-600 E	A 275-800 E <i>// NEW</i>
Version	Automatic	Automatic
Diameter	273 mm	273 mm
Height	600 mm	800 mm
Speed, lifting	12 cm/s	12 cm/s
Speed, lowering	12 cm/s	12 cm/s
Load class acc. to EN 124	D400 (40 tonnes)	D400 (40 tonnes)
Automatic lowering in case of power failure (via battery)	●	●
Automatic safety cut-out (can be deactivated)	●	●
Integrated electromechanical operator	●	●
Cycles (approx. per day)	100	100
Overall cycles (max. service life)	200000	200000
Impact energy with destruction	150000 J	150000 J
Impact energy without destruction	20000 J	20000 J
Temperature range	-40°C – +70°C*	-40°C – +70°C*

* For temperatures below -10°C, we recommend an optional heater

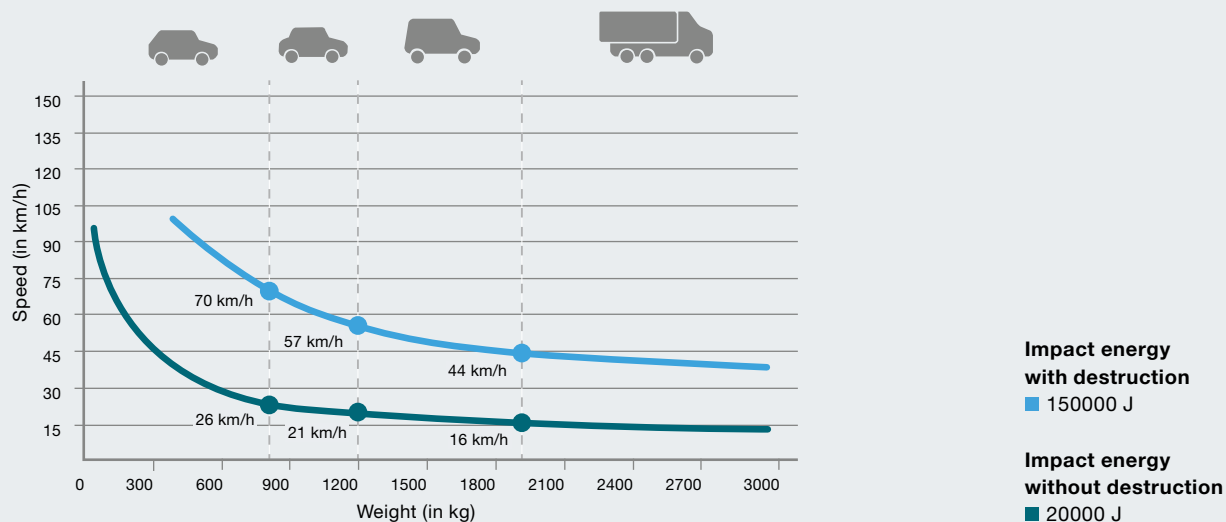

Automatic bollards H

With integrated hydraulic operator



A 220-600 H / A 220-800 H A 275-600 H / A 275-800 H

- For high use frequencies (approx. 2000 cycles / day)
- Automatic lifting and lowering by integrated hydraulic operator
- A 275-600 / A 275-800 H: Optionally with EFO emergency function (Emergency Fast Operation)
- Control unit can be extended to control multiple bollards simultaneously
- Distance between bollard and control unit of up to 80 m

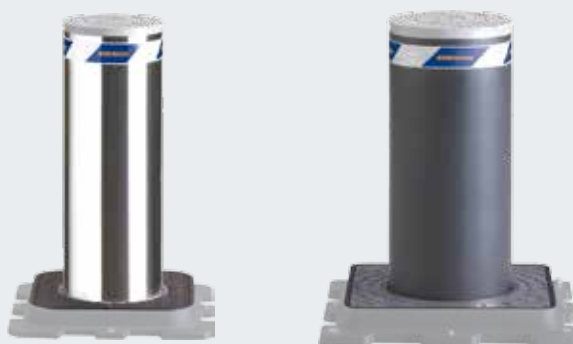

● Standard equipment ○ Optional equipment
For information about the equipment options, see pages 30–31.

	A 220-600 H	A 220-800 H	A 275-600 H	A 275-800 H
Version				
Diameter	220 mm	220 mm	273 mm	273 mm
Height	600 mm	800 mm	600 mm	800 mm
Speed, lifting	15 cm/s	15 cm/s	15 cm/s	15 cm/s
Speed, lowering	25 cm/s	25 cm/s	25 cm/s	25 cm/s
Load class acc. to EN 124	D400 (40 tonnes)	D400 (40 tonnes)	D400 (40 tonnes)	D400 (40 tonnes)
Manual emergency lowering in case of power failure	●	●	●	●
Automatic lowering in case of power failure	○	○	○	○
EFO emergency function			○	○
Automatic safety cut-out (can be deactivated)	●	●	●	●
Integrated hydraulic operator	●	●	●	●
Cycles (approx. per day)	2000	2000	2000	2000
Overall cycles (max. service life)	3000000	3000000	3000000	3000000
Impact energy with destruction	150000 J	150000 J	250000 J	250000 J
Impact energy without destruction	30000 J	30000 J	40000 J	40000 J
Temperature range	-40°C – +70°C*	-40°C – +70°C*	-40°C – +70°C*	-40°C – +70°C*

* For temperatures below -10°C, we recommend an optional heater

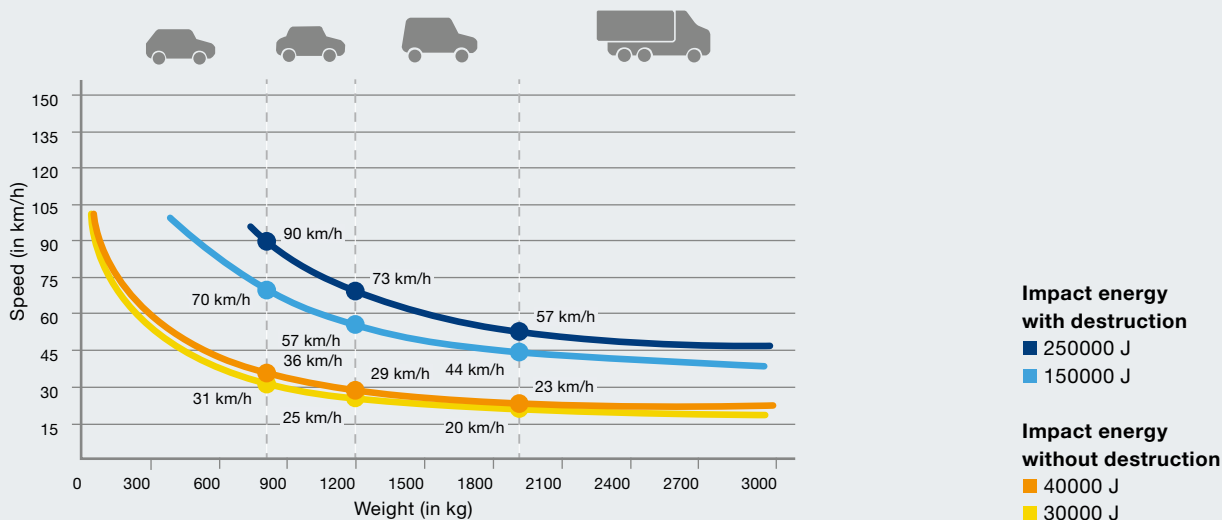

Automatic bollards RI-H

With integrated hydraulic operator

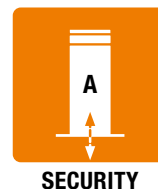

A 275-RI-600 H / A 275-RI-800 H

- For high use frequencies (approx. 2000 cycles / day)
- **Especially high protection level thanks to reinforced cylinder material**
- Automatic lifting and lowering by integrated hydraulic operator
- Optionally with EFO emergency function (Emergency Fast Operation)
- Control unit can be extended to control multiple bollards simultaneously
- Distance between bollard and control unit of up to 80 m



● Standard equipment ○ Optional equipment

For information about the equipment options, see pages 30 – 31.

	A 275-RI-600 H	A 275-RI-800 H
Diameter	273 mm	273 mm
Height	600 mm	800 mm
Speed, lifting	15 cm/s	15 cm/s
Speed, lowering	25 cm/s	25 cm/s
Load class acc. to EN 124	D400 (40 tonnes)	D400 (40 tonnes)
Manual emergency lowering in case of power failure	●	●
Automatic lowering in case of power failure	○	○
EFO emergency function	○	○
Automatic safety cut-out (can be deactivated)	●	●
Integrated hydraulic operator	●	●
Cycles (approx. per day)	2000	2000
Overall cycles (max. service life)	3000000	3000000
Impact energy with destruction	400000 J	400000 J
Impact energy without destruction	40000 J	40000 J
Temperature range	-40°C – +70°C*	-40°C – +70°C*

* For temperatures below -10°C, we recommend an optional heater

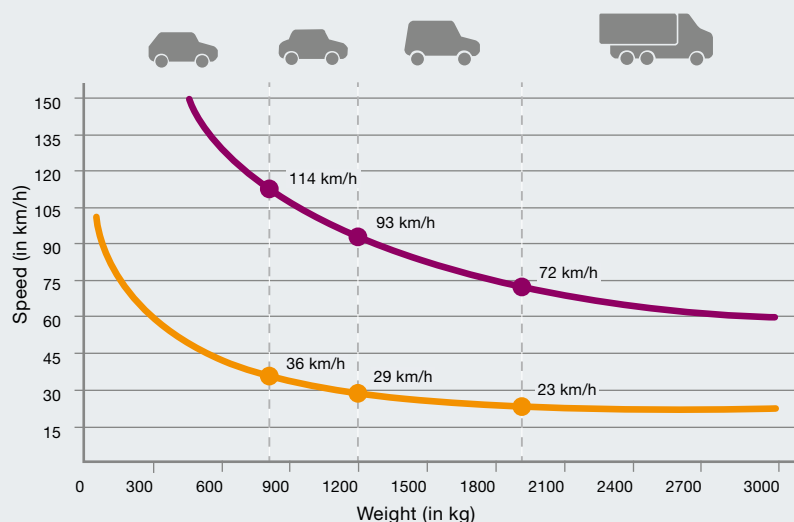

Impact energy with destruction
■ 400000 J

Impact energy without destruction
■ 40000 J

Semi-automatic bollards G

With integrated gas spring



SECURITY

S 220-600 G / S 220-800 G

S 275-600 G / S 275-800 G

- For less frequent use (approx. 5 cycles / day)
- **No power supply required**
- Manual lowering of bollard by depressing it, automatic lifting by integrated gas spring



● Standard equipment

For information about the equipment options, see pages 30 – 31.

	S 220-600 G	S 220-800 G	S 275-600 G	S 275-800 G
Diameter	220 mm	220 mm	273 mm	273 mm
Height	600 mm	800 mm	600 mm	800 mm
Speed, lifting	20 cm/s	20 cm/s	20 cm/s	20 cm/s
Speed, lowering	Manual	Manual	Manual	Manual
Load class acc. to EN 124	D400 (40 tonnes)	D400 (40 tonnes)	D400 (40 tonnes)	D400 (40 tonnes)
Integrated gas spring	●	●	●	●
Cycles (approx. per day)	5	5	5	5
Overall cycles (max. service life)	3000000	3000000	3000000	3000000
Impact energy with destruction	150000 J	150000 J	250000 J	250000 J
Impact energy without destruction	30000 J	30000 J	40000 J	40000 J
Temperature range	-40°C – +70°C	-40°C – +70°C	-40°C – +70°C	-40°C – +70°C

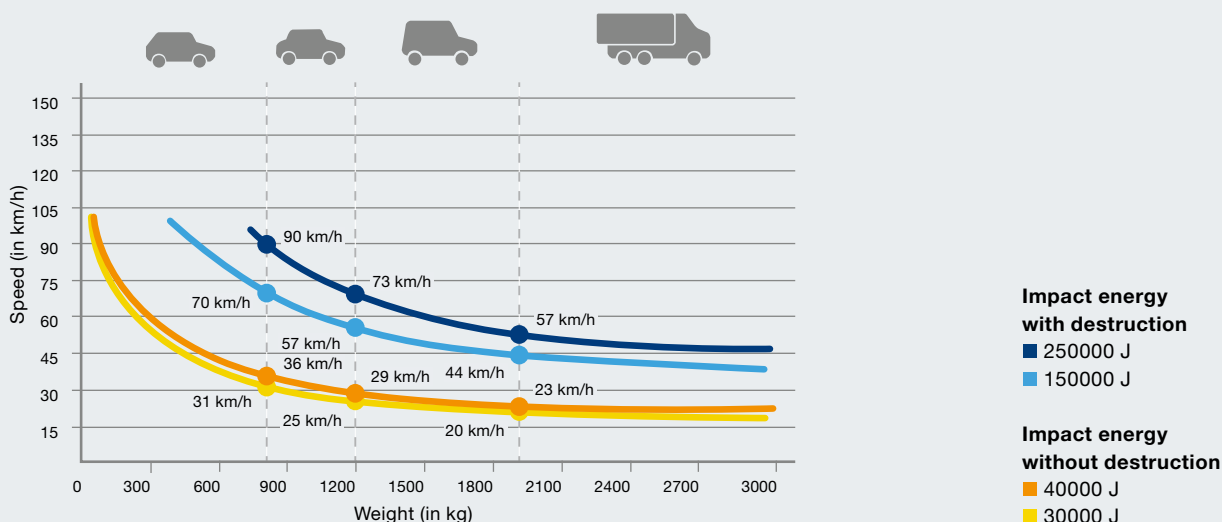

Removable bollards

With closed socket



R 275-600

- For very infrequent use (approx. 2 cycles / day)
- **Can be detached without tools**
- Fitting retractable to ground level
- No floor opening when bollard is removed



Closed socket when bollard is removed

For information about the equipment options, see pages 30 – 31.

	R 275-600
Diameter	273 mm
Height	600 mm
Cycles (approx. per day)	2
Impact energy with destruction	200000 J
Impact energy without destruction	40000 J

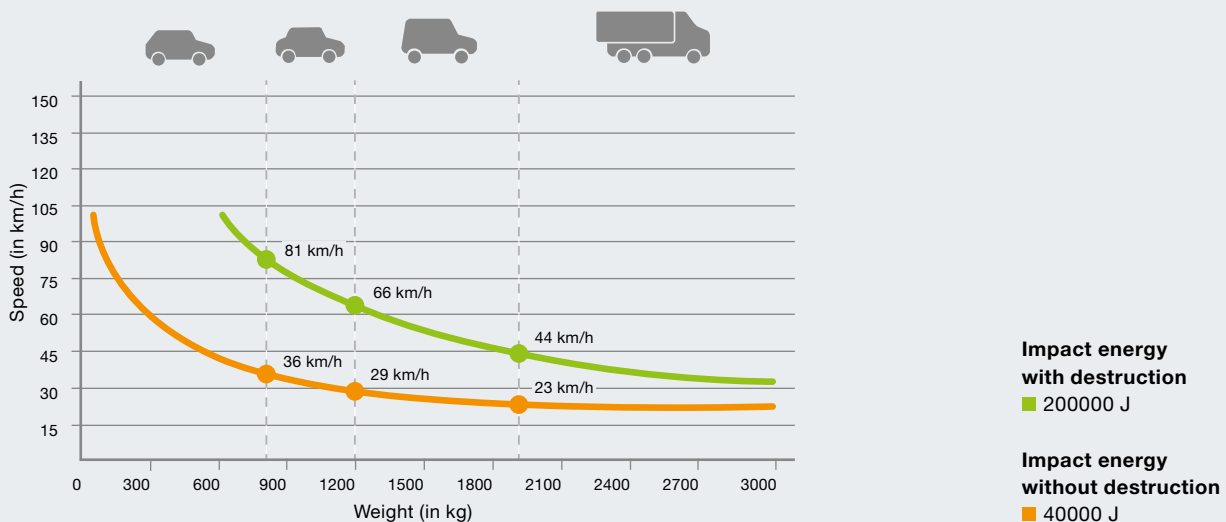

Fixed bollards CF

With bottom plate



SECURITY

F 220-600 CF / F 220-800 CF F 275-600 CF / F 275-800 CF

- Harmonious look in combination with automatic and semi-automatic bollards thanks to matching bottom plate
- Simple cylinder removal in case of damage or certain events
- Optionally with LED lighting strip for improved visibility



For information about the equipment options, see pages 30 – 31.

	F 220-600 CF	F 220-800 CF	F 275-600 CF	F 275-800 CF
Diameter	220 mm	220 mm	275 mm	275 mm
Height	600 mm	800mm	600 mm	800 mm
Impact energy with destruction	150000 J	150000 J	250000 J	250000 J
Impact energy without destruction	30000 J	30000 J	40000 J	40000 J

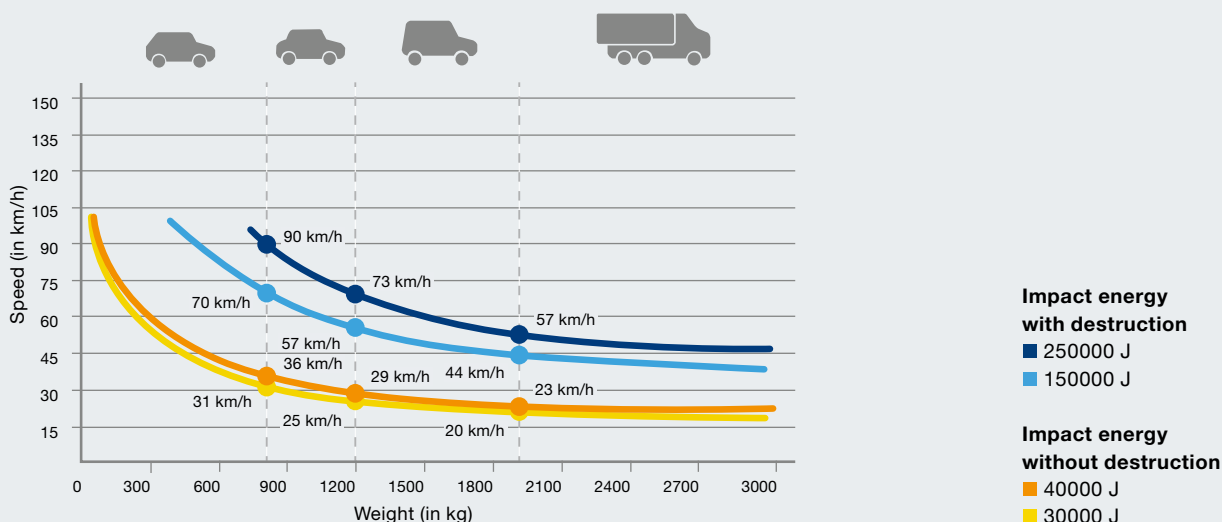

Fixed bollards BR

With ground anchor



F 220-600 BR / F 220-800 BR F 275-600 BR / F 275-800 BR

- Introductory model featuring an excellent price-performance ratio
- To secure buildings or areas without a driveway
- Can be combined with fixed HighSecurity bollards due to cylinders in matching appearance



For information about the equipment options, see pages 30 – 31.

	F 220-600 BR	F 220-800 BR	F 275-600 BR	F 275-800 BR
Diameter	220 mm	220 mm	273 mm	273 mm
Height	600 mm	800 mm	600 mm	800 mm
Impact energy with destruction	150000 J	150000 J	250000 J	250000 J
Impact energy without destruction	30000 J	30000 J	40000 J	40000 J

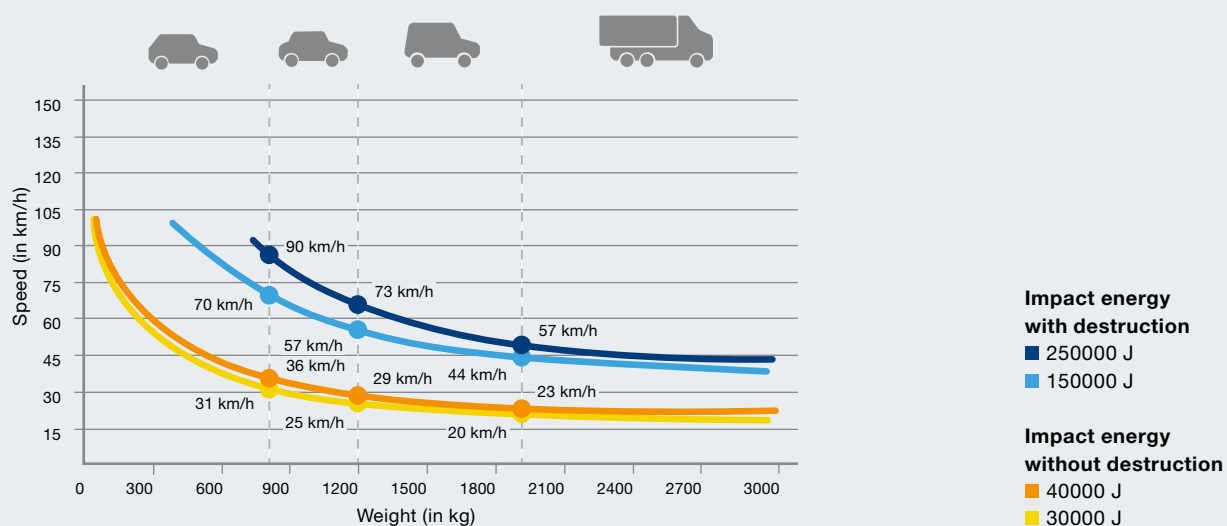

Fixed bollards RI-FF

With reinforced ground fitting



SECURITY

F 275-RI-600 FF / F 275-RI-800 FF

- Especially high protection level thanks to reinforced cylinder material and reinforced ground fitting
- To secure buildings or areas without a driveway
- Can be combined with fixed HighSecurity bollards due to cylinders in matching appearance



For information about the equipment options, see pages 30 – 31.

	F 275-RI-600 FF	F 275-RI-800 FF
Diameter	273 mm	273 mm
Height	600 mm	800 mm
Impact energy with destruction	400000 J	400000 J
Impact energy without destruction	40000 J	40000 J

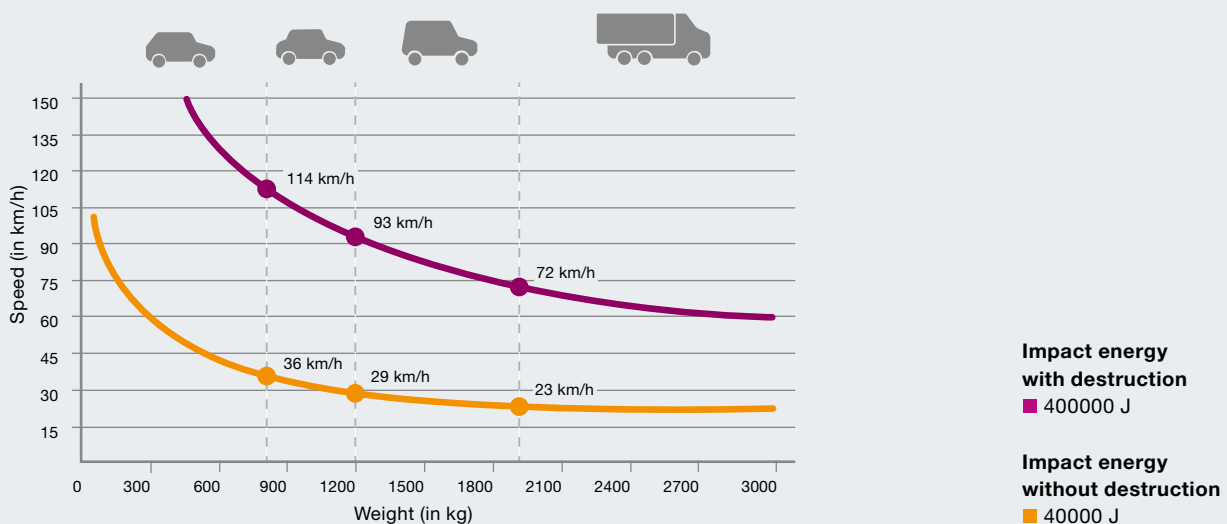

High Security Line

Maximum protection for high security areas



Electromechanical High Security bollards // NEW

The new High Security bollards with electromechanical, brushless motor are the optimal solution in case of particularly strict environmental protection requirements, since they do not require hydraulic oil. **Very easy to maintain and service.** The Soft-Start and Soft-Stop function makes cylinder movements very gentle.



Road blockers

For optimised security for entrances and exits up to 6 m wide, road blockers are recommended. They are available in the **Road Blocker 500** variant with a barrier height of 500 mm or in the **Road Blocker 1000** version with a barrier height of 1000 mm. **Road Blocker 500 SF** is suitable for fitting on finished floor surfaces since no groundwork is required.

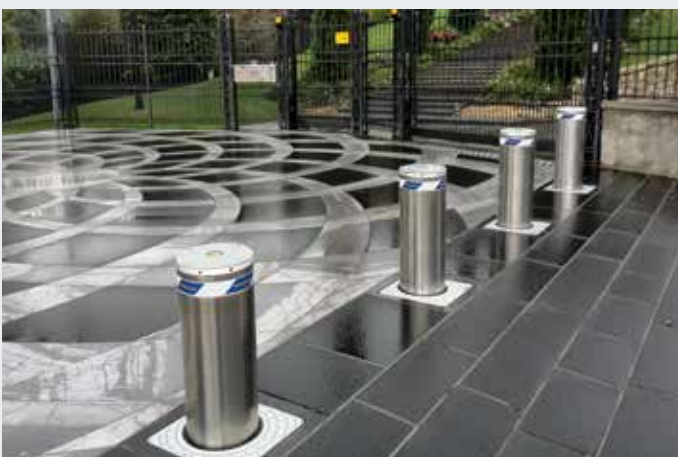

High Security bollards

High Security Line bollards are perfect for protecting sensitive areas. They are available in **automatic, removable and fixed versions**, are certified to crash tests and meet the relevant security requirements.



Tyre killers

Tyre killers enable controlled, uni-directional passage while preventing passage in the other direction. While the **Tyre Killer M** variant is suitable for average use frequencies, **Tyre Killer H** is installed for frequent use.

Safety certifications

For maximum safety and function

Real crash tests with high loads allow us to optimally prepare our innovations for the official inspections by the accredited testing centres for official approvals. In this test, a 7.5 tonne lorry (remote-controlled) crashes into a road blocker at a speed of 80 km/h, for example. The various certifications from the USA and Europe are equally recognised internationally if they meet the same requirements.



American Certification DOS SD-SDT – 02.01
Performed at Texas Transportation Institute
The Texas A&M University System, Texas U.S.A.

Crash test – K12 rating

Vehicle weight: 6.8 t
Speed: 80 km/h
Impact energy: 1679012 J

Crash test – K4 rating

Vehicle weight: 6.8 t
Speed: 50 km/h
Impact energy: 655864 J



Certification ASTM F2656-07
Performed at Karco Engineering, LLC.
Automotive Research Center, Adelanto CA, U.S.A.

Crash Test – M50 Rating

Vehicle weight: 6.8 t
Speed: 80 km/h
Impact energy: 1679012 J

Crash Test – M30 Rating

Vehicle weight: 6.8 t
Speed: 50 km/h
Impact energy: 655864 J



Certification PAS68:2013
Performed at Aisico srl
Crash Test Center, Pereto (Aq) – Italy

Crash Test – Rating PAS68:2013

Vehicle weight: 7.5 t
Speed: 80 km/h
Impact energy: 1851852 J

Crash Test – Rating PAS68:2013

Vehicle weight: 7.5 t
Speed: 50 km/h
Impact energy: 723380 J



Certification IWA14-1:2013
Performed at Aisico srl
Crash Test Center, Pereto (Aq) – Italy

Crash Test – Rating IWA14-1:2013

Vehicle weight: 7.2 t
Speed: 50 km/h
Impact energy: 694444 J

Crash Test – Rating IWA14-1:2013

Vehicle weight: 7.2 t
Speed: 80 km/h
Impact energy: 1777778 J

Comparison of the certificates from the USA, Great Britain and international certificates

Previous US testing method	Current US testing method	Current testing method Great Britain	Current international testing methods
K4	M30	PAS68	IWA14
K12	M50	PAS68	IWA14

Automatic bollards E

With brushless electromechanical operator

World's first

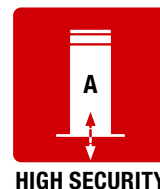

A 275-M30-900 E / A 275-M30-1200 E A 275-M50-900 E / A 275-M50-1200 E

- For high use frequencies (approx. 2000 cycles / day)
- Low maintenance, as no inspection of the hydraulics components, oil pressure and oil level is required
- **Environmentally friendly, can also be used in case of strict environmental requirements**
- Service-friendly thanks to virtually wear-free brushless 230 V motors and few operator components
- **Low-vibration and low-noise cylinder movement with Soft-Start and Soft-Stop**
- Optionally with EFO emergency function (Emergency Fast Operation)



● Standard equipment ○ Optional equipment
For information about the equipment options, see pages 30 – 31.

	A 275-M30-900 E // NEW	A 275-M30-1200 E // NEW from 01.08.2019	A 275-M50-900 E // NEW	A 275-M50-1200 E // NEW from 01.08.2019
Diameter	273 mm	271 mm	271 mm	271 mm
Height	900 mm	1200 mm	900 mm	1200 mm
Speed, lifting	20 cm/s	20 cm/s	20 cm/s	20 cm/s
Speed, lowering	20 cm/s	20 cm/s	20 cm/s	20 cm/s
Load class acc. to EN 124	D400 (40 tonnes)	D400 (40 tonnes)	D400 (40 tonnes)	D400 (40 tonnes)
Manual lowering in case of power failure	●	●	●	●
Automatic lowering in case of power failure (via battery)	○	○	○	○
EFO emergency function	○	○	○	○
Electromechanical operator	●	●	●	●
Cycles (approx. per day)	2000	2000	2000	2000
Overall cycles (max. service life)	3000000	3000000	3000000	3000000
Certified to	PAS68, IWA14-1	M30, K4	M50, K12	M50, K12, PAS68
Compliant with	M30, K4	PAS68, IWA14-1	PAS68, IWA14-1	IWA14-1
Impact energy with destruction	750000 J	1200000 J	2000000 J	2000000 J
Impact energy without destruction	250000 J	700000 J	700000 J	700000 J
Temperature range	-40°C – +70°C*	-40°C – +70°C*	-40°C – +70°C*	-40°C – +70°C*

* For temperatures below -10°C, we recommend an optional heater

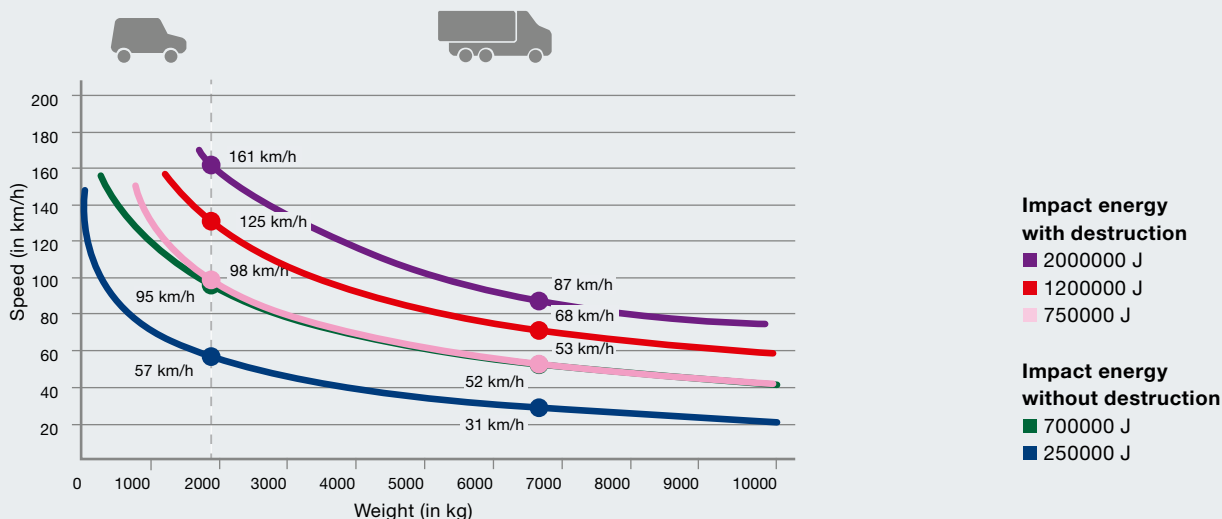

Automatic bollards H

With integrated hydraulic operator



A 275-M30-900 H / A 275-M30-1200 H A 275-M50-900 H / A 275-M50-1200 H

- For high use frequencies (approx. 2000 cycles / day)
- **Automatic lifting and lowering by integrated hydraulic operator**
- Optionally with EFO emergency function (Emergency Fast Operation)
- Control unit can be extended to control multiple bollards simultaneously
- Distance between bollard and control unit of up to 80 m



● Standard equipment ○ Optional equipment
For information about the equipment options, see pages 30 – 31.

	A 275-M30-900 H	A 275-M30-1200 H	A 275-M50-900 H	A 275-M50-1200 H
Diameter	273 mm	271 mm	271 mm	271 mm
Height	900 mm	1200 mm	900 mm	1200 mm
Speed, lifting	10 cm/s	20 cm/s	22 cm/s	22 cm/s
Speed, lowering	25 cm/s	25 cm/s	22 cm/s	22 cm/s
Load class acc. to EN 124	D400 (40 tonnes)	D400 (40 tonnes)	D400 (40 tonnes)	D400 (40 tonnes)
Manual lowering in case of power failure	●	●	●	●
EFO emergency function	○	○	○	○
Integrated hydraulic operator	●	●	●	●
Cycles (approx. per day)	2000	2000	2000	2000
Overall cycles (max. service life)	3000000	3000000	3000000	3000000
Certified to	PAS68, IWA14-1	M30, K4	M50, K12	M50, K12, PAS68
Compliant with	M30, K4	PAS68, IWA14-1	PAS68, IWA14-1	IWA14-1
Impact energy with destruction	750000 J	1200000 J	2000000 J	2000000 J
Impact energy without destruction	250000 J	700000 J	700000 J	700000 J
Temperature range	-40°C – +70°C*	-40°C – +70°C*	-40°C – +70°C*	-40°C – +70°C*

* For temperatures below -10°C, we recommend an optional heater

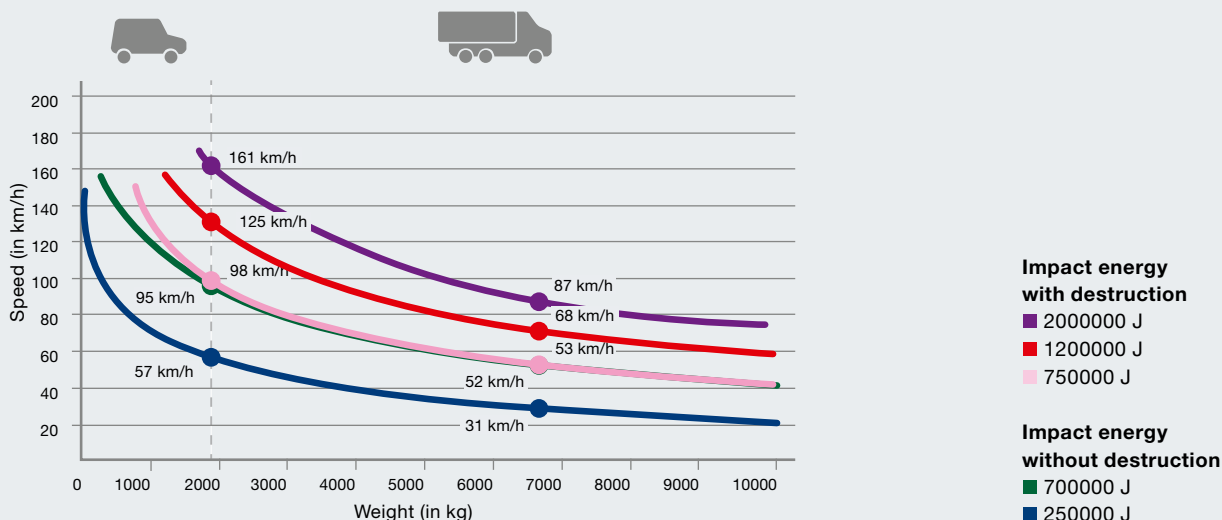

Removable bollards

With reinforced socket



R 275-M30-900

- For very infrequent use
- **Can be detached with special tool**
- Can be combined with fixed HighSecurity bollards due to cylinders in matching appearance

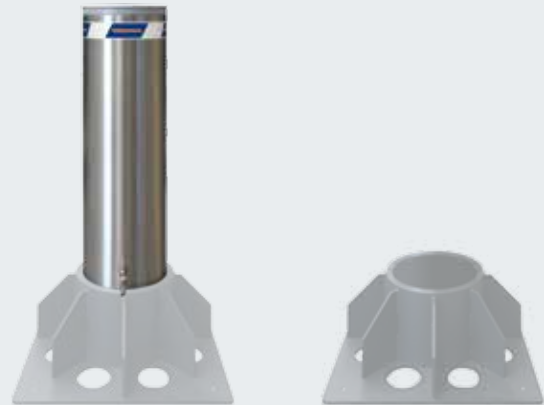

For information about the equipment options, see pages 30 – 31.

	R 275-M30-900
Diameter	273 mm
Height	900 mm
Impact energy with destruction	750000
Impact energy without destruction	250000

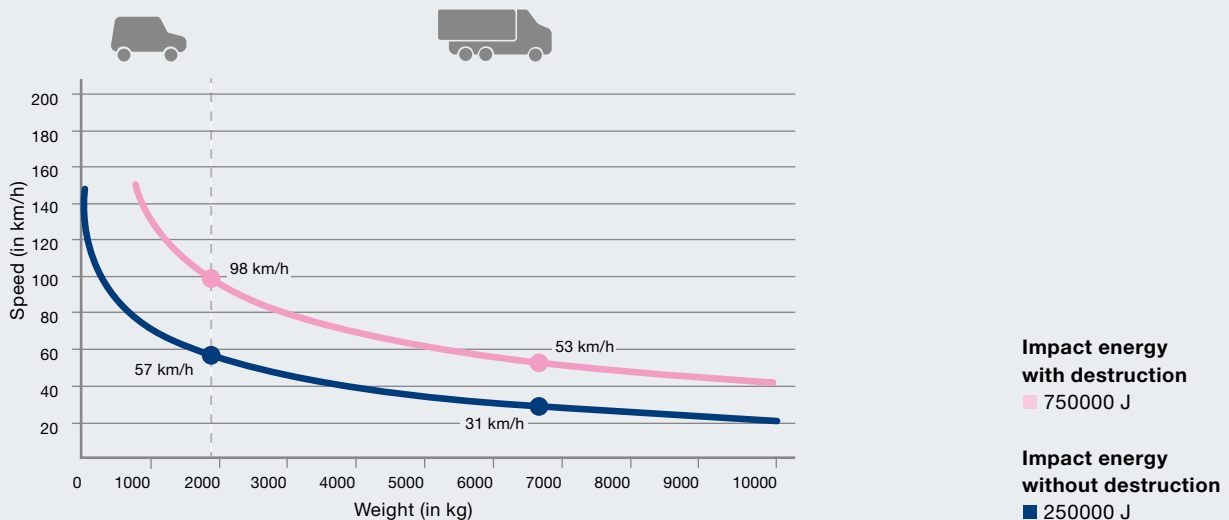

Fixed bollards FF

With reinforced ground fitting



F 275-M30-900 FF / F 275-M30-1200 FF F 275-M50-900 FF / F 275-M50-1200 FF

- Reinforced ground fitting for setting in concrete
- To secure buildings or areas without a driveway
- For combination with automatic and removable HighSecurity bollards using cylinders in matching appearance



For information about the equipment options, see pages 30 – 31.

	F 275-M30-900 FF	F 275-M30-1200 FF	F 275-M50-900 FF	F 275-M50-1200 FF
Diameter	273 mm	271 mm	271 mm	271 mm
Height	900 mm	1200 mm	900 mm	1200 mm
Certified to // NEW	M30, K4, PAS68, IWA14-1	M30, K4, PAS68, IWA14-1	M50, K12, PAS68, IWA14-1	M50, K12, PAS68, IWA14-1
Impact energy with destruction	750000 J	1200000 J	2000000 J	2000000 J
Impact energy without destruction	250000 J	700000 J	700000 J	700000 J

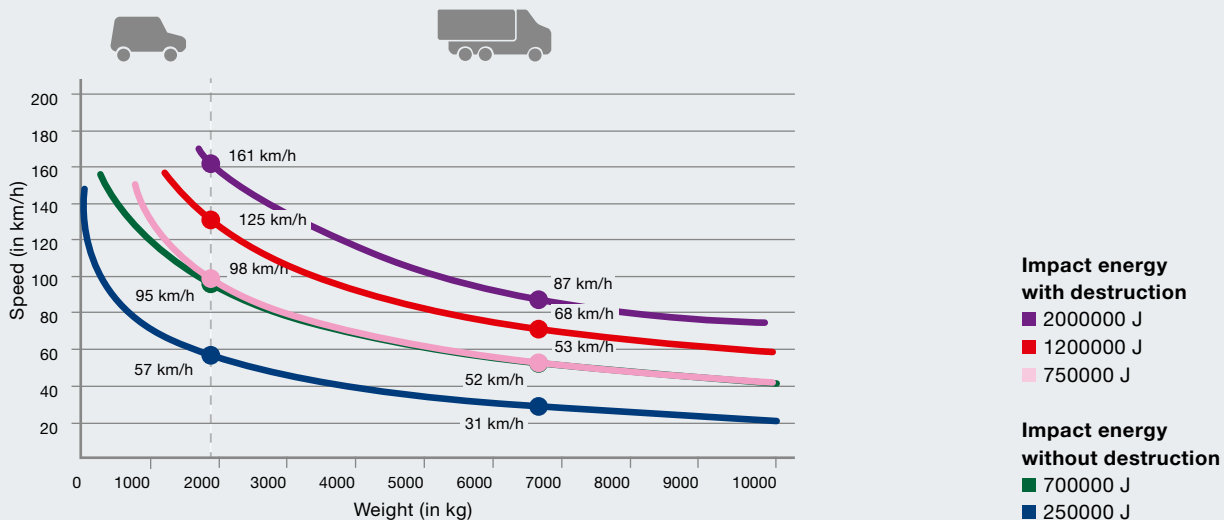

Road blockers

To secure passages up to 6 m wide



HIGH SECURITY

Road Blocker 500

- For high use frequencies (approx. 2000 cycles / day)
- **Barrier height 500 mm**
- Flush-fitting to floor
- External hydraulic operator (max. distance 30 m)
- Optionally with EFO emergency function (Emergency Fast Operation)



Road Blocker 1000

- For high use frequencies (approx. 2000 cycles / day)
- **Barrier height 1000 mm**
- Flush-fitting to floor
- External hydraulic operator (max. distance 30 m)
- Optionally with EFO emergency function (Emergency Fast Operation)

● Standard equipment ○ Optional equipment

For information about the equipment options, see page 32.

	Road Blocker 500	Road Blocker 1000
Ramp height above ground level	500 mm	300 mm
Standard length	2, 3, 4, 5, 6 m	2, 3, 4, 5, 6 m
Fitting depth	500 mm	300 mm
External hydraulic operator	●	●
Speed, lifting	10 cm/s	14.5 cm/s
Speed, lowering	10 cm/s	14.5 cm/s
EFO emergency function	○	○
Manual operation	○	○
LED lighting strips	○	○
Protective sections	●	●
Load class acc. to EN 124	D400 (40 tonnes)	D400 (40 tonnes)
Cycles (approx. per day)	2000	2000
Overall cycles (max. service life)	3000000	3000000
Certified to		PAS68
Compliant with	M30, K4, PAS68, IWA14-1	M50, K12, IWA14-1
Impact energy with destruction	750000 J	2000000 J

Road blockers

To secure passages up to 6 m wide



Road Blocker 500 SF

- For high use frequencies (approx. 2000 cycles / day)
- Barrier height 500 mm
- Integrated hydraulic operator
- **Simple, fast fitting on finished floor surface, no groundwork required**



● Standard equipment ○ Optional equipment
For information about the equipment options, see page 32.

	Road Blocker 500 SF
Height	500 mm
Standard length	3.5 – 4.5 – 5.5 m
Fitting depth	0 mm
Integrated hydraulic pump	●
Speed, lifting	7 cm/s
Speed, lowering	5 cm/s
Manual operation	○
LED lighting strips	○
Load class acc. to EN 124	D400
Cycles (approx. per day)	2000
Overall cycles (max. service life)	3000000
Impact energy with destruction	400000 J

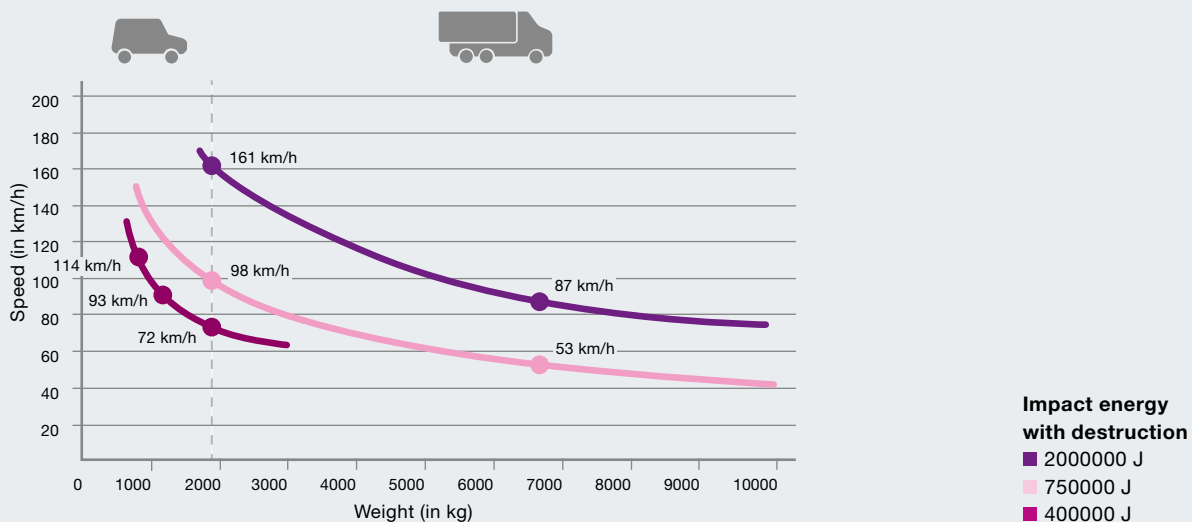

Tyre killers

To secure passages in one direction



Tyre Killer M

- For average use frequencies (approx. 100 cycles / day)
- **Fitting on finished floor surface, no groundwork required**
- Spikes lifted by counter weights
- Optional: locking device when retracted to enable passage in both directions

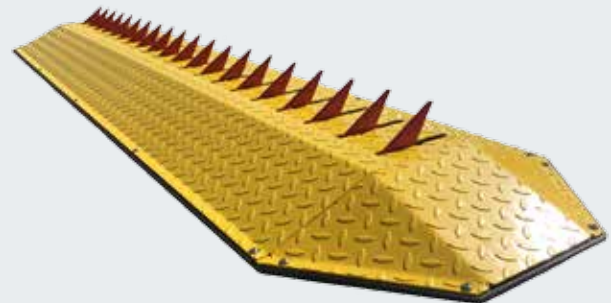

Tyre Killer H

- For high use frequencies (approx. 2000 cycles / day)
- **Flush-fitted to floor**
- External hydraulic operator (max. distance 30 m)
- Optionally with EFO emergency function (Emergency Fast Operation)

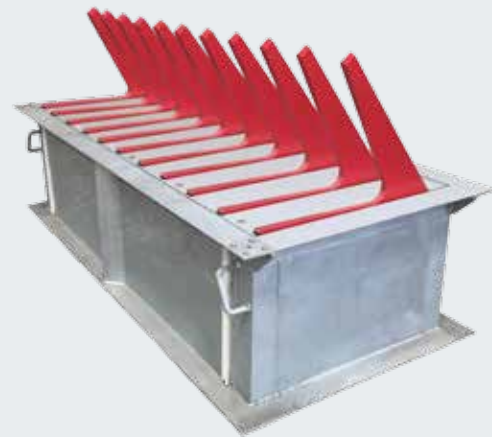

● Standard equipment ○ Optional equipment

For information about the equipment options, see page 32.

	Tyre Killer M	Tyre Killer H
Height of spikes above ground level	61 mm	501 mm
Length	2, 3, 4, 5, 6 m	2, 3, 4, 5, 6 m
Spike width	10 mm	20 mm
Spike spacing	105 mm	200 mm
Fitting depth	-	660 mm
Extension via counter weight	●	
Extension by integrated hydraulic operator		●
Manual lowering		●
EFO emergency function		○
Locking device	○	○
Cycles (approx. per day)	100	2000
Load class acc. to EN 124	D250	D250
Overall cycles (max. service life)	200000	3000000

Standard Equipment

Bollards



1 Cylinder cover

- ABS plastic (Security Line)
- Aluminium with anti-corrosion coating (High Security Line)



2 Cylinder surface

- Steel, coated in Anthracite grey RAL 7016



3 Reflecting strips

- Better visibility at night
- All-round



4 Automatic safety cut-out

- Stops lifting of automatic bollards in case of obstacles (Security Line)
- Can be deactivated

Optional Equipment

Bollards



Steel surface finishes

- Anti-corrosion coating
- Coating in RAL to choose

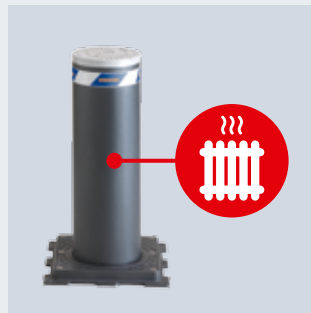

Heating element

- Reliable operation
- in areas at risk of snow and ice



Stainless steel surfaces

- V2 A or V4 A
- K180 (polished)
- Coating in RAL to choose



UPS uninterruptible power supply

- To bypass power failures for up to 10 cycles
- Recharges during normal operation



LED lighting strips

- Better visibility at night
- Warning light when bollard is lifted and lowered
- All-round



EFO emergency function

- Fast extension within approx. 1.5 s in emergency situations for automatic bollards with hydraulic operator



Reaction in case of power failure

- Automatic lowering of automatic bollards
- Emergency manual operation to lift and lower



Acoustic warning signal

- Warning signal when lifting and lowering bollard

Additional equipment variants and options on request.

Optional Equipment

Road blockers and tyre killers

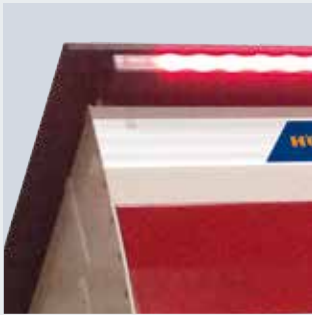

LED lighting strips

- Better visibility at night
- Warning light when bollard is lifted and lowered
- For road blockers

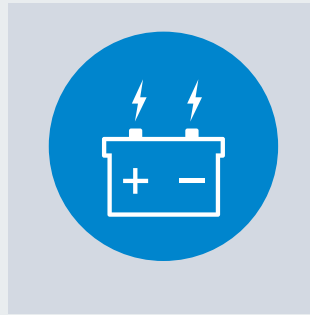

UPS uninterruptible power supply

- To bypass power failures for up to 10 cycles
- Recharges during normal operation

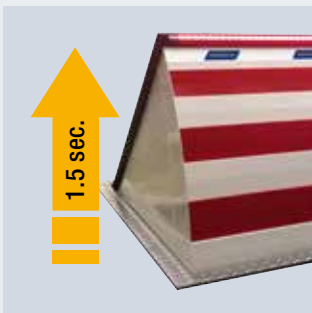

EFO emergency function

- Fast extension within approx. 1.5 s in emergency situations

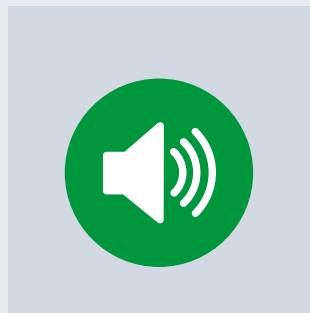

Acoustic warning signal

- Warning signal when lifting and lowering



Reaction in case of power failure

- Manual emergency operation

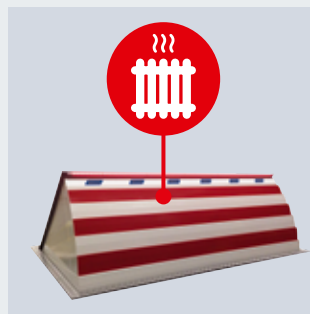

Heating element

- Reliable operation in areas at risk of snow and ice
- For road blockers

Additional equipment variants and options on request.

Key switch posts

For perimeter protection and access regulation

Key switch post, stainless steel 170

- Operation of automatic bollards directly at the bollard
- Perimeter protection using key switches, transponder key switches and code switches
- Access regulation using 1-sided or 2-sided traffic lights (red / green)
- To accommodate up to max. 2 bollard controls (only for variant that opens to the top)

Key switch post, stainless steel 275

- Operation of automatic bollards directly at the bollard
- Harmonious appearance in combination with bollards with diameters of 275 mm
- Accommodates control for up to 4 bollards
- Perimeter protection using key switches, transponder key switches and code switches
- Access regulation using 1-sided or 2-sided traffic lights (red / green)
- Maintenance flap with lock



● Standard equipment ○ Optional equipment

	Key switch post, stainless steel 170	Key switch post, stainless steel 275
Diameter	170 mm	275 mm
Heights	1500, 1800 mm	1500, 1800 mm
Fixed	●	●
Key switch post opening to the top	○	
Mounting base	●	●
Lockable maintenance flap		●
Protection category	IP 55	IP 55



1
Stainless steel surface, coated in Anthracite grey RAL 7016 (as standard), coating in RAL to choose (optional)



2
Stainless steel surface, polished finish, K240 (brushed)



3
Maintenance flap (for stainless steel key switch post 275)



4
Perimeter protection using key switches, transponder key switches and code switches



5
Access regulation using 1-sided or 2-sided traffic lights (red / green)

Accessories

Radio control, receiver



Only from Hörmann

Hörmann BiSecur (BS)

State-of-the-art radio system for door control and perimeter protection systems

The bi-directional BiSecur radio system is based on future-oriented technology for convenient and secure operation. The extremely secure BiSecur encryption protocol makes sure that no one can copy your radio signal. It was tested and certified by security experts at the Ruhr-Universität Bochum.

Your advantages

- 128-bit encryption with the same high security level as online banking
- Interference-resistant radio signal with a stable range
- Compatible with Hörmann door control and perimeter protection systems



5-button hand transmitter HS 5 BS
High-gloss black or white, with chrome caps



5-button hand transmitter HS 5 BS
Black textured surface with chrome caps



4-button hand transmitter HS 4 BS
Black textured surface with chrome caps



1-button hand transmitter HS 1 BS
Black textured surface with chrome caps



4-button security hand transmitter HSS 4 BS
Additional function: copy protection for hand transmitter coding, with chrome caps



2-button hand transmitter HSE 2 BS
High-gloss black or white, with chrome caps



4-button hand transmitter HSE 4 BS
Black textured surface with chrome or plastic caps



1-button hand transmitter HSE 1 BS
Black textured surface with chrome caps



Accessories

Code switches, finger-scans, transponder key switches



**Industrial hand transmitter
HSI BS**

To control up to 1000 receivers, with a display and extra-large quick selection buttons for easier operation with work gloves, transferring of hand transmitter coding to other devices possible

**Industrial hand transmitter
HSI 6 BS, HSI 15 BS**

To control up to 6 / 15 receivers, with extra-large buttons for easier operation with work gloves, impact-resistant housing
Protection category: IP 65



**Radio code switch
FCT 3 BS**

For 3 functions, with illuminated buttons

**Radio code switch
FCT 10 BS**

For 10 functions, with illuminated buttons and protective cover

**Radio finger-scan
FFL 12 BS**

For 2 functions and up to 12 fingerprints



**2-channel relay receiver
HET-E2 SL BS**

With 2 volt-free relay outputs for choosing the direction, one 2-pin input for volt-free Retracted/Extended limit switch reporting, external antenna

Gateway BS

Central interface for operation of automatic perimeter protection systems via smartphone or tablet, up to 10 users with a max. of 16 functions

Accessories

Code switches, finger-scans, transponder key switches



Code switch CTR 1b-1, CTR 3b-1
For 1 (CTR 1b-1) or 3 (CTR 3b-1) functions, with illuminated buttons

Dimensions:
80 × 80 × 15 mm (W × H × D)

Code switch CTV 3-1
For 3 functions, with particularly robust metal keypad

Dimensions:
80 × 80 × 15 mm (W × H × D)

Code switch CTP 3
For 3 functions, with illuminated lettering and touch-sensitive surface

Dimensions:
80 × 80 × 15 mm (W × H × D)

Decoder housing
For code switch CTR 1b-1, CTR 3b-1, CTV 3-1, CTP 3

Dimensions:
140 × 130 × 50 mm (W × H × D),
Keypad protection category: IP 65
Decoder housing protection category: IP 54
Switching capacity: 2.5 A / 30 V DC
500 W / 250 V A



Finger-scan FL 150
For 2 functions, up to 150 fingerprints can be saved

Dimensions:
80 × 80 × 13 mm (W × H × D)
Decoder housing:
70 × 275 × 50 mm (W × H × D)
Switching capacity: 2.0 A / 30 V DC

Transponder key switch TTR 1000-1
For 1 function via transponder key or transponder card, up to 1000 keys or cards can be saved

Dimensions:
80 × 80 × 15 mm (W × H × D)
Decoder housing:
140 × 130 × 50 mm (W × H × D),
Switching capacity: 2.5 A / 30 V DC
500 W / 250 V AC

Accessories

Activating kits, key switches,
LED traffic lights



Traffic lights with bright,
long-lasting LEDs



DI 1 induction loop in a separate additional housing

Suitable for one induction loop. The detector has a normally open contact and a change-over contact. DI 2 induction loop (not shown) in a separate additional housing. Suitable for two separate induction loops. The detector has two volt-free normally open contacts. Can be set for impulse or permanent contact, directional recognition possible.

Dimensions of additional housing:
202 × 164 × 130 mm (W × H × D)

Switching capacity:

DI 1: low voltage 2 A, 125 V A/60 W

DI 2: 250 V AC, 4 A, 1000 VA (resistive load AC), supplied without loop cable

Loop cable for induction loop
50 m roll, cable designation: SIAF,
cross-section: 1.5 mm², colour: brown

Digital weekly timer in a separate additional housing

The timer can switch command units on and off via a volt-free contact. Switching capacity: 230 V AC 2.5 A / 500 W
Can be switched over to summer / winter time
Manual switching: automatic operation, switching preselection "permanently ON / OFF"

Dimensions of additional housing:

202 × 164 × 130 mm (W × H × D)

Protection category: IP 65

Digital yearly timer in additional housing

The timer can switch command units on and off via a volt-free contact. Switching capacity: 230 V AC 2.5 A / 500 W
Can be switched over to summer / winter time
Manual switching: automatic operation, switching preselection "permanently ON / OFF"

Dimensions of additional housing:

202 × 164 × 130 mm (W × H × D)

Protection category: IP 65



Key switch ESU / ESA 30

With 3 keys, impulse or "Open / Close" function selectable

Dimensions of switch box:

60 mm (d), 58 mm (D)

Dimensions of cover:

90 × 100 mm (W × H)

Wall recess:

65 mm (d), 60 mm (D)

Protection category: IP 54

Key switch STUP / STAP 50

With 3 keys

Dimensions:

80 × 80 mm (W × H)

Protection category: IP 54

Traffic lights red / green

As a visual indicator of authorized or blocked passage, not in combination with stainless steel key switch posts

Dimensions: 180 × 250 × 290 mm (W × H × D)

Contact load: 250 V AC: 2.5 A / 500 W

Protection category: IP 65

Hörmann Product Range

Everything from a single source for your construction project





Quick service with testing, maintenance and repairs
Our extensive service network means that we are always nearby and at your service around the clock.

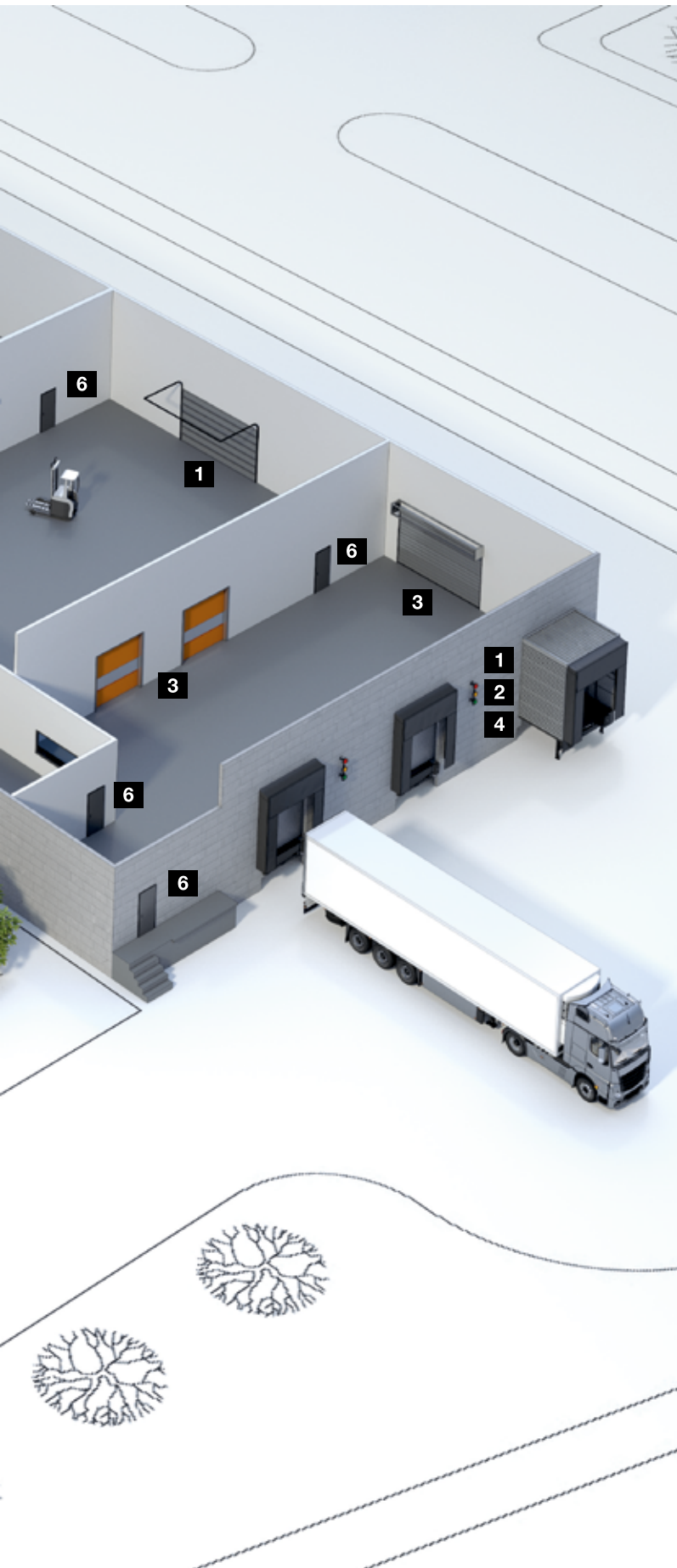

Sectional doors



Rolling shutters and rolling grilles



High-speed doors



Loading technology



Steel and stainless steel sliding doors



Steel and stainless steel construction project doors



Steel frames with high-quality timber function doors from Schörghuber



Tubular frame construction project doors



Automatic sliding doors



Visibility window



Collective garage doors



Bollards and road blockers



Barrier and pay station systems

Hörmann: Quality without Compromise



Hörmann KG Amshausen, Germany



Hörmann KG Antriebstechnik, Germany



Hörmann KG Brandis, Germany



Hörmann KG Brockhagen, Germany



Hörmann KG Dissen, Germany



Hörmann KG Eckelhausen, Germany



Hörmann KG Freisen, Germany



Hörmann KG Ichttershausen, Germany



Hörmann KG Werne, Germany



Hörmann Alkmaar B.V., Netherlands



Hörmann Legnica Sp. z o.o., Poland



Hörmann Beijing, China



Hörmann Tianjin, China



Hörmann LLC, Montgomery IL, USA



Hörmann Flexon LLC, Burgettstown PA, USA



Shakti Hörmann Pvt. Ltd., India

Hörmann is the only manufacturer worldwide that offers you a complete range of all major building products from one source. We manufacture in highly-specialised factories using the latest production technologies. The close-meshed network of sales and service companies throughout Europe, and activities in the USA and Asia, make Hörmann your strong partner for first-class building products, offering “Quality without Compromise”.

GARAGE DOORS
OPERATORS
INDUSTRIAL DOORS
LOADING EQUIPMENT
HINGED DOORS
DOOR FRAMES